

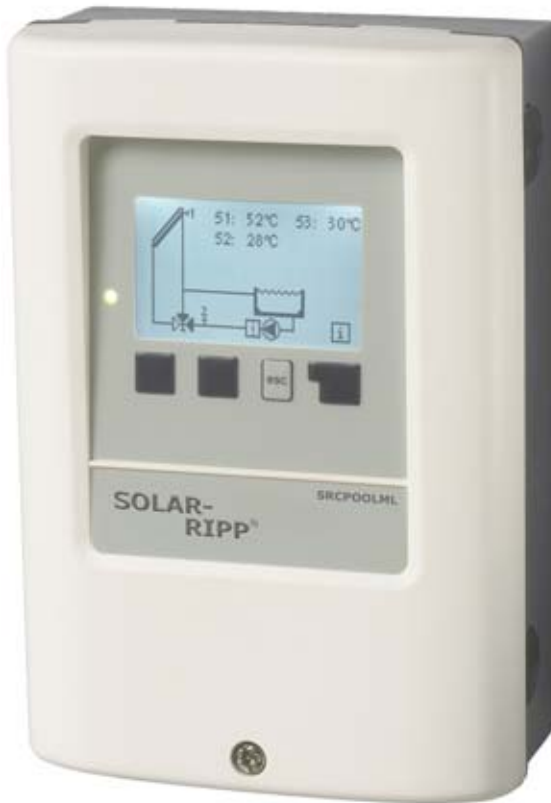

# SRCPOOLMLFPR

## Installation and operating instructions



Read carefully before installation, commissioning and operation

# Table of Contents

	page	page
<b>Safety instructions</b>		
<b>A.1. EC declaration of conformity</b>	<b>3</b>	
<b>A.2. General instructions</b>	<b>3</b>	
<b>A.3. Explanation of symbols</b>	<b>3</b>	
<b>A.4. Changes to the unit</b>	<b>4</b>	
<b>A.5. Warranty and liability</b>	<b>4</b>	
<b>Description of controller</b>		
<b>B.1. Specifications</b>	<b>5</b>	
<b>B.2. Temperature resistance table</b>	<b>5</b>	
<b>B.3. About the controller</b>	<b>6</b>	
<b>B.4. Scope of supply</b>	<b>6</b>	
<b>B.5. Disposal and pollutants</b>	<b>6</b>	
<b>B.6. Hydraulic variants</b>	<b>7</b>	
<b>Installation</b>		
<b>C.1. Wall installation</b>	<b>8</b>	
<b>C.2. Electrical connection</b>	<b>9</b>	
<b>C.3. Installing the temperature sensors</b>	<b>10</b>	
<b>D. Terminal connection diagram</b>	<b>11</b>	
<b>Operation</b>		
<b>E.1. Display and input</b>	<b>12</b>	
<b>E.2. Commissioning help</b>	<b>13</b>	
<b>E.3. Free commissioning</b>	<b>13</b>	
<b>E.4. Menu sequence and menu structure</b>	<b>14</b>	
<b>1. Measurement values</b>	<b>15</b>	
<b>2. Statistics</b>	<b>16</b>	
2.1. Operating hours	16	
2.2. Average pool temperature	16	
2.3. Heat output	16	
2.4. Graphic overview	16	
2.5. Message log	16	
2.6. Reset/clear	16	
<b>3. Display mode</b>	<b>17</b>	
3.1. Schematic	17	
3.2. Overview	17	
3.3. Alternating	17	
3.4. Sleep mode	17	
<b>4. Operating mode</b>	<b>18</b>	
4.1. Automatic	18	
4.2. Manual	18	
4.3. Off	18	
<b>5. Settings</b>	<b>19</b>	
5.1. Tmin S1	19	
5.2. Tmax S2	19	
5.3. $\Delta T$ R1	20	
5.4. Tset S2	20	
5.5. Hysteresis	20	
5.6. Follow up / Switch-off delay	20	
5.7. Delay / Switch-on delay		20
Filter pump run time		20
5.8. Hourly filter pump run time		20
5.9. Eco mode		21
5.10. Run time optimization		21
5.11. Daily filtering time		21
5.12. Solar times		21
5.13. Heating times		21
<b>6. Protective functions</b>	<b>21</b>	
6.1. Seizing protection		21
6.2. Frost protection		21
6.3. System protection		22
<b>7. Special functions</b>	<b>23</b>	
7.1. Program selection		23
7.2. Time and date		23
7.3. Sensor calibration		23
7.4. Commissioning		24
7.5. Factory settings		24
7.6. Heat quantity		24
7.7. Daylight saving time		25
<b>8. Menu lock</b>	<b>26</b>	
<b>9. Service values</b>	<b>27</b>	
<b>10. Language</b>	<b>28</b>	
<b>Malfunctions</b>		
<b>Z.1. Malfunctions with error messages</b>	<b>29</b>	
<b>Z.2. Replacing the fuse</b>	<b>30</b>	
<b>Z.3. Maintenance</b>	<b>30</b>	

# Safety instructions

## A.1. EC declaration of conformity

By affixing the CE mark to the unit the manufacturer declares that this device conforms forms to the following relevant safety regulations:

- EC low voltage directive 2006/95/EC
- EC electromagnetic compatibility directive 2004/108/EC

Conformity has been verified and the corresponding documentation and the EC declaration of conformity are kept on file by the manufacturer.

## A.2. General instructions

These installation and operating instructions contain basic instructions and important information regarding safety, installation, commissioning, maintenance and the optimal use of the unit. Therefore these instructions must be read completely and understood by the installation technician/specialist and by the system user before installation, commissioning and operation of the unit.

The valid accident prevention regulations, VDE regulations, the regulations of the local power utility, the applicable DIN-EN standards and the installation and operating instructions of the additional system components must also be observed. The controller does not under any circumstances replace any safety devices which are to be provided by the customer!

Installation, electrical connection, commissioning and maintenance of the unit may only be carried out by specialists who have the appropriate training.

For the user: Make sure that the specialist gives you detailed information on the function and operation of the controller. Always keep these instructions in the vicinity of the controller.

## A.3. Explanation of symbols



Failure to observe these instructions can result in danger to life from electric voltage.



Failure to observe these instructions can result in serious damage to health such as scalding, or even life-threatening injuries.



Failure to observe these instructions can result in destruction of the unit or the system, or damage to the environment.



Information which is especially important for the function and optimal use of the unit and the system.

# Safety instructions

## A.4. Changes to the unit



Changes to the unit can compromise the safety and function of the unit or the entire system.

- Changes, additions to or conversion of the unit are not permitted without written authorisation from the manufacturer
- It is likewise forbidden to install additional components that have not been tested together with the unit
- If it becomes clear that safe operation of the unit is no longer possible, for example because of damage to the housing, turn the controller off immediately
- Any parts of the unit or accessories that are not in perfect condition must be replaced immediately
- Use only original spare parts and accessories from the manufacturer
- Markings made on the unit at the factory must not be altered, removed or made illegible
- Only the settings described in these instructions may be used on the controller

## A.5. Warranty and liability

The controller has been manufactured and tested with regard to high quality and safety requirements. The unit is subject to the statutory guarantee period of two years from the date of sale.

The warranty and liability shall not include, however, any injury to persons or material damage that is attributable to one or more of the following causes:

- Failure to observe these installation and operating instructions
- Improper installation, commissioning, maintenance and operation
- Improper repairs
- Unauthorised structural changes to the unit
- Installation of additional components that have not been tested together with the unit
- Any damage resulting from continued use of the unit despite an obvious fault
- Failure to use original spare parts and accessories
- Use of the device for anything other than its intended purpose
- Operation above or below the limit values listed in the specifications
- Force majeure

# Description of controller

## B.1. Specifications

### Electrical specifications:

Mains voltage	230 VAC +/-10 %
Mains frequency	50 - 60 Hz
Power consumption	1.5 W - 2.3 W
Internal fuse	4 A slow blow 250 V
Protection category seal kit)Protection class	IP40 / IP 44 (only with the supplied II
Overvoltage Category	II
Degree of Pollution Category	II

mechanical relay 4 A maximum AC3	2 (R1-R2)
sensor input measuring range -40 °C to 300 °C	3

\* Note to 3 ~ and 1 ~ pumps, see below, on this side

### Permissible cable length of sensors and appliances:

Collector and outdoor sensor	< 30 m
sensors	< 10 m
Electronic relay	< 3 m
Mechanical relay	< 10 m

### Real Time Clock

RTC with 24 hour power reserve

### Permissible ambient conditions:

Ambient temperature	
for controller operation	0 °C ... 40 °C
for transport/storage	0 °C ... 60 °C
Air humidity	
for controller operation	max. 85 % rel. humidity at 25 °C
for transport/storage	no moisture condensation permitted

### Other specifications and dimensions

Housing design	3-part, ABS plastic
Installation methods	Wall installation, optional panel
Overall dimensions	163 mm x 110 mm x 52 mm
Cut out installation dimensions	157 mm x 106 mm x 31 mm
Display	Fully graphical display, 128 x 128 dots
Light diode	Multicolor red / green
Operation	4 entry keys

## B.2. Temperature resistance table

°C	0	10	20	30	40	50	60	70	80	90	100
Ω	1000	1039	1077	1116	1155	1194	1232	1270	1308	1347	1385

### \* note:

3 ~: You also can switch 3 ~ pumps with the control.

1 ~: You also can switch 1 ~ pumps of higher current intensity with the control.

# Description of controller

## B.3. About the controller

The Pool Controller SRCPOOL facilitates efficient use and function control of your solar or heating system with your swimming pool. The device is impressive most of all for its functionality and simple, almost self-explanatory operation. For each step in the input process the individual entry keys are assigned to appropriate functions and explained. The controller menu contains headwords for the measured values and settings, as well as help texts or clearly-structured graphics.

The SRCPOOL can be used as a solar controller for the various system variants illustrated and explained under "B.6. Hydraulic variants" on page 7.

Important characteristics of the SRCPOOL

- Depiction of graphics and texts in an illuminated display
- Simple viewing of the current measurement values
- Analysis and monitoring of the system by means of statistical graphics, etc.
- Individual configuration of special functions
- Extensive menu settings with explanations
- Menu block activation to prevent unintentional setting changes
- Resetting to previously selected values or factory settings
- A wide range of additional functions

## B.4. Scope of supply

- Pool Controller Pool SRCPOOL
- 3 pcs. 3.5 x 35 mm screws and 3 pcs. 6 mm plugs for wall installation
- 6 strain relief clips with 12 screws, replacement fuse 1x T 4 A / 250 V
- Installation and operating instructions SRCPOOL
- Optionally contained depending on design/order:
  - temperature sensors and immersion sleeves
- Additionally available:
  - temperature sensor, immersion sleeves, overvoltage protection

## B.5. Disposal and pollutants

The unit conforms to the European RoHS directive 2011/65/EU for the restriction of the use of certain hazardous substances in electronic equipment.



The unit must not under any circumstances be disposed of with ordinary household refuse. Dispose of the unit only at appropriate collection points.

# Description of controller

## B.6. Hydraulic variants



The following illustrations should be viewed only as schematic diagrams showing the respective hydraulic systems and do not claim to be complete. The controller does not replace safety devices under any circumstances. Depending on the specific application, additional system components and safety components may be required, such as check valves, non-return valves, safety temperature limiters, scalding protectors etc. and must therefore be provided.

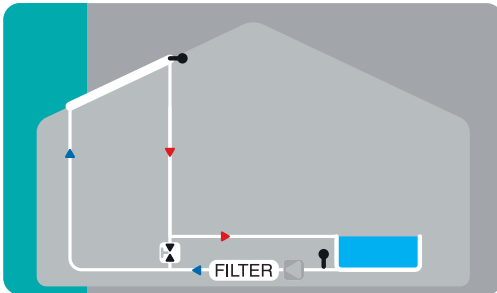

Pool+Solar / Solar with valve, filter pump and pool

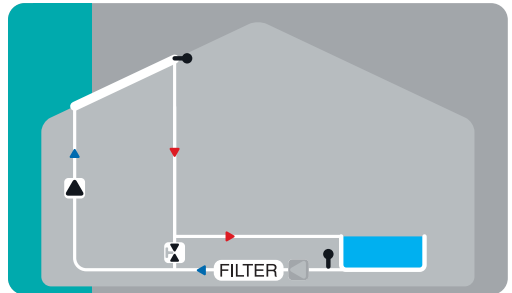

Pool Solar+additional pump / Solar with additional pump, valve and pool

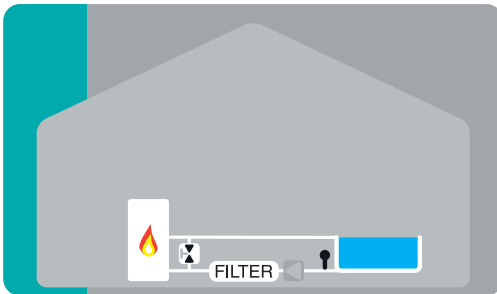

Pool + heat request / Additional heating with valve and pool

# Installation

## C.1. Wall installation



Install the controller in dry areas only and under the ambient conditions described under “B.1. Specifications”.

### C.1.1.

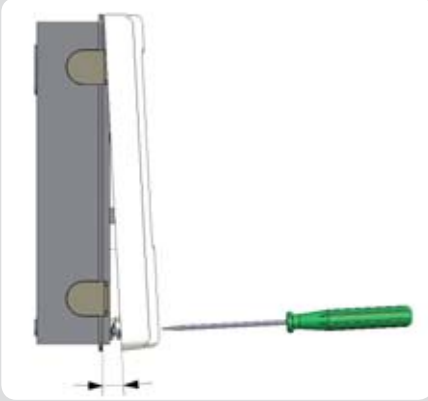

1. Unscrew cover completely
2. Carefully pull upper part of housing from lower part. Terminal clamps are released during this process.
3. Set upper part of housing aside, being sure not to touch the electrics when doing so.
4. Hold the lower part of the housing up to the selected position and mark the 3 mounting holes. Make sure that the wall surface is as even as possible so that the housing does not become distorted when it is screwed on.

### C.1.2.

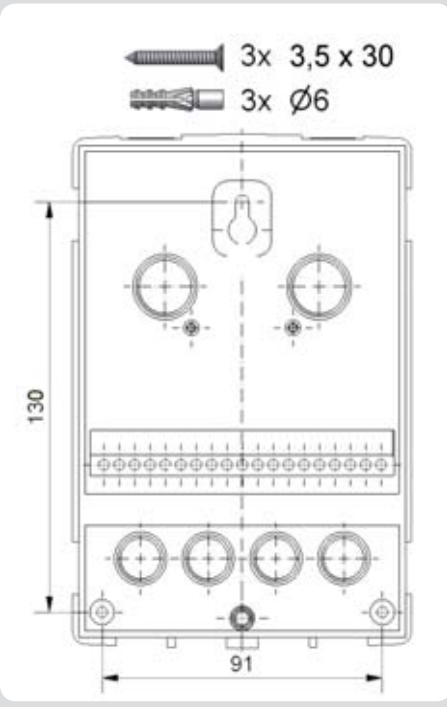

5. Using a drill and size 6 bit, drill 3 holes at the points marked on the wall and push in the plugs.
6. Insert the upper screw and screw it in slightly.
7. Fit the upper part of the housing and insert the other two screws.
8. Align the housing and tighten the three screws.



Controller must be inaccessible from the rear.



# Installation

## C.2. Electrical connection



Before working on the unit, switch off the power supply and secure it from being switched on again! Check for the absence of power!

Electrical connections may only be made by a specialist and in compliance with the applicable regulations.

Do not use the controller if the housing shows visible damage.



Low-voltage cables such as temperature sensor cables must be routed separately from the mains voltage cables. Feed temperature sensor cables only into the left-hand side of the unit, and mains voltage cables only into the right-hand side.



The customer must provide an all-pole disconnecting device, e.g. a heating emergency switch.



The cables being connected to the unit must not be stripped by more than 55 mm, and the cable jacket must reach into the housing just to the other side of the strain relief.

Follow the protective areas to German Institute for Standardization VDE 0100-702 for the installation of the control (distances to Schutzbereich 0 and 1).



Electric shock danger by improper connection!

- VDE-and EVU regulations of the energy supply enterprise follow.
- Pumps and swimming pools and their protective area according to German Institute for Standardization VDE 0100-702 instal.
- Dividing device for the interruption of the tension care with min 3 mm of contact opening per pool instal.



Electric shock danger by tension in the case!

- A correctly opposed engine guard counter must be installed. Besides, the values on the type sign follow.
- Circuit with a mistake stream protection counter, nominal mistake stream  $I \Delta N \leq 30 \text{ mA}$ .
- Only suitable management types accordingly of the regional regulations use.
- Least cross section of the lines, the engine power and the achievement situation adapt.
- If dangerous situations can arise, emergency-from counter according to German Institute for Standardization EN 809 plan. According to this norm the Errichter/operator must decide this.

# Installation

## C.2.2.

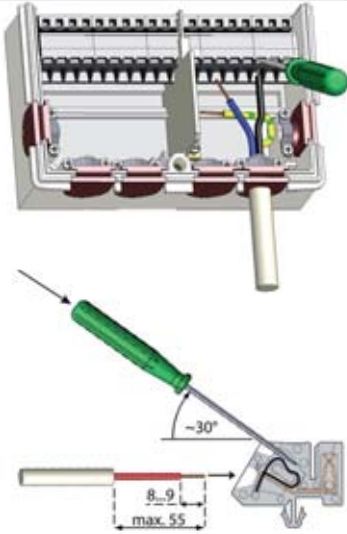

1. Select necessary program/hydraulics.
2. Open controller casing (“C.1.Wall installation” on page 8).
3. Strip cables by 55 mm max., insert, fit the strain relief devices, strip the last 8-9 mm of the wires.
4. Open the terminals using a suitable screwdriver (Fig. C.2.1.) and make electrical connections on the controller.
5. Refit terminal connection cover and fasten screw.
6. Switch on mains voltage and place controller in operation.

## C.3. Installing the temperature sensors

The controller operates with temperature sensors which are accurate to the degree, thus ensuring optimal control of system functions.



If desired the sensor cables can be extended to a maximum of 30 m using a cable with a cross-section of at least 0.75 mm<sup>2</sup>. Make sure that there is no contact resistance!

Position the sensor precisely in the area to be measured!

Only use immersion, pipe-mounted or flat-mounted sensors suitable for the specific area of application with the appropriate permissible temperature range.



The temperature sensor cables must be routed separately from mains voltage cables and must not, for example, be routed in the same cable duct!

# Installation

## D. Terminal connection diagram

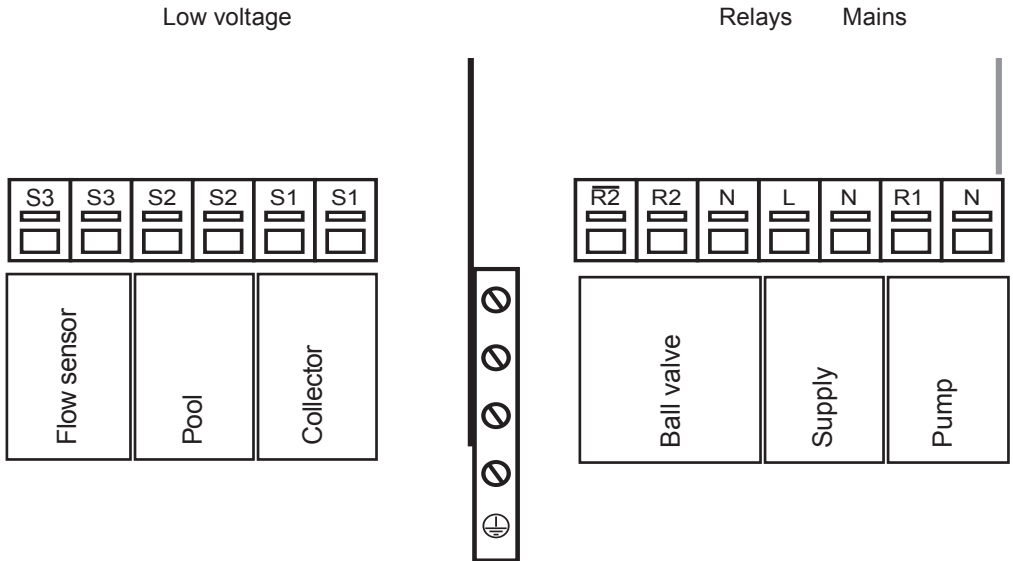

max. 12 V

**Low voltage** max. 12 VAC/DC

Terminal	Connection for
S1 (2x)	Collector
S2 (2x)	Pool
S3 (2x)	Flow sensor (optional)



Mains voltages 230 VAC

**Mains voltage** 230 VAC 50-60 Hz

Terminal	Connection for
N	Mains neutral conductor N
R1	Prim. pump / Heat request
N	Mains neutral conductor N
L	Mains phase conductor L
N	Mains neutral conductor N
R2	Ball valve
R2	Ball valve





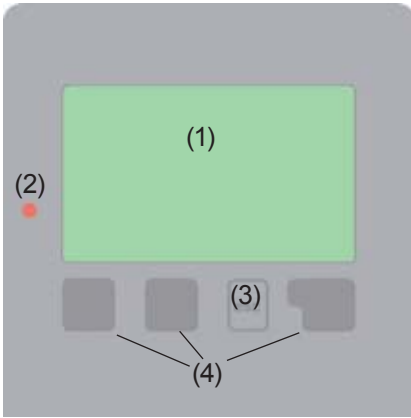

The PE protective conductor must be connected to the PE metal terminal block!

# Operation

## E.1. Display and input



Examples of display symbols:

-  Pump (rotates in operation)
-  Collector
-  Pool
-  Temperature sensor
-  Warning / Error message
-  New infos

The display (1), with its extensive text and graphics mode, is almost self-explanatory, allowing easy operation of the controller.

To change from the overview to the settings menu, press the „esc“ key.

The green status LED (2) lights up when a solar requirement ist aktiv (Ball value on/off) Other features of the LED are described in nChapter Z.1.

Inputs are made with 4 buttons (3 + 4), which have different functions depending on the context.

The „esc“ key (3) is always used to cancel or exit a menu.

If applicable there will be a request for confirmation as to whether the changes which have been made should be saved.

The function of each of the other three keys (4) is shown in the display line directly above the keys; the right-hand key generally has a confirmation and selection function.

Examples of key functions:

- +/- = enlarge/shrink values
- ▼/▲ = scroll down/up menu
- yes/no = approve/cancel
- Info = additional information
- Back = to previous screen
- ok = confirm selection
- Confirm = confirm setting

# Commissioning

## E.2. Commissioning help



The first time the controller is turned on and after the language and time are set, a query appears as to whether you want to parametrise the controller using the commissioning help or not. The commissioning help can also be terminated or called up again at any time in the special functions menu. The commissioning help guides you through the necessary basic settings in the correct order, and provides brief descriptions of each parameter in the

display. Pressing the “esc” key takes you back to the previous value so you can look at the selected setting again or adjust it if desired. Pressing the “esc” key more than once takes you back step by step to the selection mode, thus cancelling the commissioning help. Finally, the menu “4.2. Manual” on page 18 should be used to test the switch outputs with the consumers connected and to check the sensor values for plausibility. Then the automatic mode can be switched on.



Observe the explanations for the the individual parameters on the following pages and check whether further settings are necessary for your application.

## E.3. Free commissioning

If you decide not to use the commissioning help, you should make the necessary settings in the following sequence:

- Menu 10. Language
- Menu 7.2. Time and date
- Menu 7.1. Program selection
- Menu 5. Settings, all values
- Menu 6. Protective functions, if necessary
- Menu 7. Special functions, if necessary

Finally, the menu “4.2. Manual” on page 18 should be used to test the switch outputs with the consumers connected and to check the sensor values for plausibility. Then the automatic mode can be switched on.



Observe the explanations for the individual parameters on the following pages and check whether further settings are necessary for your application.

# Operation

## E.4. Menu sequence and menu structure

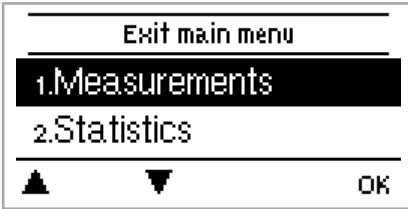
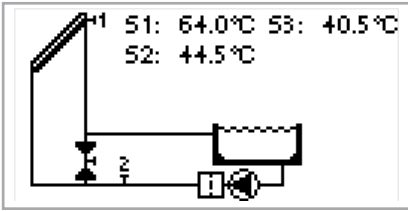

1. Measurement values

Current temperature values with explanations

2. Statistics

Function control of the system with operating hours etc.

3. Display mode

Select graphics mode or overview mode

4. Operating mode

Automatic mode, manual mode or switch unit off

5. Settings

Set parameters needed for normal operation

6. Protective functions

Frost protection, anti-seizing protection etc.

7. Special functions

Program selection, sensor calibration, clock, additional sensor etc.

8. Menu lock

Against unintentional setting changes at critical points

9. Service values

For diagnosis in the event of an error

10. Language

Language selection

# Measurement values

## 1. Measurement values

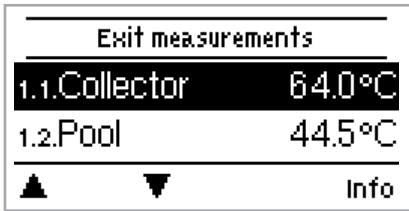

The menu “1. Measurement values” serves to display the currently measured temperatures.

The menu is closed by pressing the “esc” key or selecting “Exit measurement values”.

The measurement values are explained with a help text when selected.

Selecting “Overview” or “esc” exits the Info mode.



If “--” appears on the display instead of the measurement value, then there may be a faulty or incorrect temperature sensor. If the cables are too long or the sensors are not placed optimally, the result may be small deviations in the measurement values. In this case the display values can be compensated for by making entries on the controller. Follow the instructions under “7.3. Sensor calibration” on page 23.

What measurement values are displayed depends on the selected program, the connected sensors and the specific device design.

# Statistics

## 2. Statistics



The menu "2. Statistics" is used for function control and long-term monitoring of the system.

The menu is closed by pressing the "esc" key or selecting "Exit statistics".



For analysis of the system data it is essential for the time to be set accurately on the controller. Please note that the clock only has a battery reserve for 24 hours and must therefore be reset afterwards. Improper operation or an incorrect time may result in data being deleted, recorded incorrectly or overwritten.

The manufacturer accepts no liability for the recorded data!

### 2.1. Operating hours

Display of operating hours of the pump connected to the controller; various time ranges (day-year) are available.

### 2.2. Average pool temperature

Displays the average pool temperature.

### 2.3. Heat output

Displays the system's heat output. See also "7.6. Heat quantity" on page 25

### 2.4. Graphic overview

This provides a clearly organised display of the data listed under 2.1. ... 2.2. as a bar graph. Various time ranges are available for comparison. The two left-hand keys can be used to page through the data.

### 2.5. Message log

Displays the last 20 events occurring in the system with indication of date and time.

### 2.6. Reset/clear

Resetting and deleting the individual analyses. The function "All statistics" clears all analyses but not the error messages.



# Display mode

## 3. Display mode

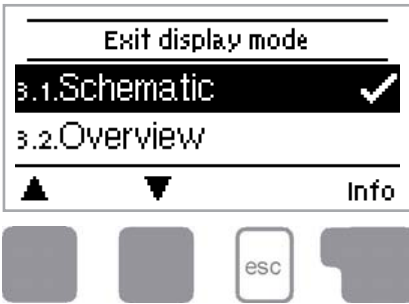

The menu “3. Display mode” is used to define the controller’s display for normal operation.

This display appears whenever two minutes go by without any key being pressed. The main menu appears again when a key is pressed.

The menu is closed by pressing the “esc” key or selecting “Exit display mode”.

### 3.1. Schematic

In graphics mode, the selected hydraulic systems are depicted with the measured temperatures and operating states of the connected consumers.

### 3.2. Overview

In overview mode, the measured temperatures and operating states of the connected consumers are depicted in text form.

### 3.3. Alternating

In alternating mode the schematic mode and then the overview mode are active for 5 seconds at a time.

### 3.4. Sleep mode

When active, the display’s backlight is switched off after 2 minutes of inactivity.



If a message is waiting, the backlight is not switched off.

# Operating mode

## 4. Operating mode

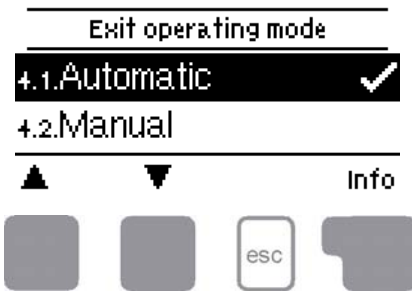

In the menu "4. Operating mode" the controller can either be placed in automatic mode, switched off or placed in a manual operating mode.

The menu is closed by pressing the "esc" key or selecting "Exit operating mode".

### 4.1. Automatic

Automatic mode is the normal operating mode of the controller. Only automatic mode provides proper controller function taking into account the current temperatures and the parameters that have been set! After an interruption of the mains voltage the controller automatically returns to the last operating mode selected!

### 4.2. Manual

The relay and thus the connected consumer are switched on and off, with no regard to the current temperatures and the parameters which have been set, by pressing a key. The measured temperatures are also shown to provide an overview and function control.



When operating mode "Manual" is activated, the current temperatures and the selected parameters are no longer considered. There is a danger of scalding or serious damage to the system. The operating mode "Manual" may only be used by specialists for brief function tests or during commissioning!

### 4.3. Off



When the operating mode "Off" is activated, all controller functions are switched off. This can lead, for example, to overheating on the solar collector or other system components. The measured temperatures are still displayed to provide an overview.

# Settings

## 5. Settings

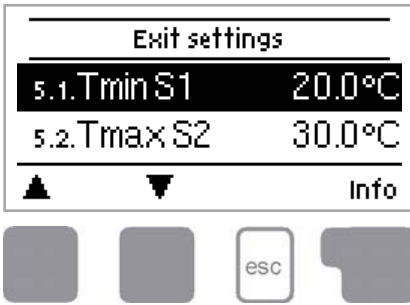

The necessary basic settings required for the control function are made in menu "5. Settings".



This does not under any circumstances replace the safety facilities to be provided by the customer!

The menu is closed by pressing the "esc" key or selecting "Exit settings".



The following pages contain generally valid descriptions for the settings. Enumerations may vary.

### 5.1. Tmin S1

#### Enable/start temperature at sensor 1

If this value is exceeded at sensor 1 and the other conditions are also met, then the controller switches the associated pump and/or ball value on. If the temperature at sensor 1 drops below this value by 5 °C, the pump and/or the valve are switched off again. *Setting range: 0 °C ... 99 °C / Default: 20 °C*

### 5.2. Tmax S2

#### Switch-off temperature at sensor 2

If this value is exceeded at sensor 2, the controller switches the associated pump and/or valve off. If sensor 2 falls below this value again and the other conditions are also met, the controller switches the pump and/or ball value on again.

*Setting range: 0 °C ... 99 °C / Default: 30 °C*



Temperature values which are set too high can lead to scalding or damage to the system. Scalding protection must be provided by the customer!

# Settings

## 5.3. $\Delta T$ R1

### Switch-on/switch-off temperature difference for relay R1

If this temperature difference is reached, the ball valve at R2 and the pump at R1 are switched on. When the temperature drops to  $\Delta T$ -Off, pump / valve are switched off.

*Setting range:  $\Delta T$ -On 4 °C ... 20 °C / Default 10 °C*

*$\Delta T$ -Off 2 °C ... 9 °C / Default: 3 °C*



If the set temperature difference is too small, this may result in ineffective operation, depending on the system and sensor positions.



Reference sensors are usually S1 and S2.

If S3 is connected, the switch Off  $\Delta T$ -Off is between S2 and S3.

## 5.4. Tset S2

Target temperature for sensor 2. Below this temperature the heating is switched on until  $T_{\text{soil}} + \text{Hysteresis}$  is reached. *Setting range: 0 °C ... 40 °C / Default: 20 °C*

## 5.5. Hysteresis

Hysteresis for heating. *Setting range: 0 °C ... 10 °C / Default: 5 °C*

## 5.6. Follow up / Switch-off delay

After the switch-off conditions for the solar pump are met, the pump keeps running for the time set here. If the switch-off conditions change during this time and are not met anymore, the pumps keeps running.

*Setting range: 0 ... 30 min / Default: 1 min*

## 5.7. Delay / Switch-on delay

When all switch-on conditions are met to activate the pump, the pump is not switched on for the time set here. This prevents that on cloudy day, the pumps turn on for short sunshine.

*Setting range: 0 ... 30 min / Default: 1 min*

## Filter pump run time

The Pool TDCM+ controls the pool temperature taking into account solar energy and the runtime of the filter pump. During Eco mode the filter pump run time is calculated regarding the hourly and daily filter run times.

*Setting range: off, daily 0:00 ... 23:59 hour / Default: daily 0:00 ... 23:59 hour*

## 5.8. Hourly filter pump run time

This menu is used to set the hourly minimum filter pump run time.

Eco mode: If the solar pump was not active during the last hour, the filter pump is switched on for the set time.

# Settings

## 5.9. Eco mode

When the Eco mode is inactive, the hourly run time and the solar operating hours are ignored when calculating the daily filter pump run times. The solar operating hours are also ignored when calculating the hourly filter pump run time.

*Setting range: On, Off*

## 5.10. Run time optimization

When the run time optimization is active, the „hourly filter pump run time“ is reduced in regards of the average pool temperature of the past hour. When the average pool temperature was 30 °C, the hourly filter pump run time is fully committed. When the average pool temperature was 20 °C, the hourly filter pump run time is halved (and the solar run time is subtracted afterwards). The runtime-to-time dependency is calculated in 5 % steps per °C. Example: 20 °C = 50 %, 25 °C = 75 %, 27 °C = 85 %, 30 °C = 100 % *Setting range: off, daily 0:00 ... 23:59 hour / Default: daily 0:00 ... 23:59 hour*

## 5.11. Daily filtering time

Used to ensure that the filter system is at least running for the time set here regardless of temperature. Eco mode: The time the filter pump was running on this day is subtracted from the time span set here. Example: Daily filtering time is set to run between 16 and 19 o'clock = 3 hours. The filter pump was already active for 2 hours during the day. The remaining 1 hour means that the pump will be switched on between 18 and 10 o'clock.

## 5.12. Solar times

During the periods set here the solar system is enabled.

*Setting range: off, daily 0:00... 23:59 o'clock / Default: daily 0:00... 23:59 o'clock*

## 5.13. Heating times

During the periods opposed here the heating system is released.

*Setting range: off, daily 0:00... 23:59 o'clock / Default: daily 0:00... 23:59 o'clock*

# Protective functions

## 6. Protective functions



The menu "6. Protections / Protective functions" can be used to activate and set various protective functions.



This does not under any circumstances replace the safety facilities to be provided by the customer!

The menu is closed by pressing the "esc" key or selecting "Exit protective functions".

# Protective functions

## 6.1. Seizing protection

If the seizing protection is activated, the controller switches the relay in question and the connected consumer on every day at 12:00 (setting “daily”) or weekly on Sundays at 12:00 (setting “weekly”) for 5 seconds in order to prevent the pump and/or the ball valve from sticking after an extended stationary period.

*Setting range R1: daily, weekly, off / Default: off*

*Setting range R2: daily, weekly, off / Default: off*

## 6.2. Frost protection

A two-stage frost protection function can be activated. In stage 1 the controller switches the pump on for 1 minute every hour if the collector temperature drops below the set value “Frost stage 1”.

If the collector temperature drops further to the set value “Frost stage 2” the controller switches the pump on continuously.

If the collector temperature then exceeds the value “Frost stage 2” by 2 °C, the pump switches off again.

*Frost protection setting range: on, off / Default: off*

*Frost stage 1 setting range: from -25 °C ... 10 °C or off / Default: 7 °C*

*Frost stage 2 setting range: from -25 °C ... 8 °C / Default: 5 °C*



This function causes energy to be lost via the collector! It is normally not activated for solar systems with antifreeze. This function does not render the emptying of absorbers during the cold season obsolete.

Observe the operating instructions for the other system components!

## 6.3. System protection

### Highest priority protection

System protection prevents the system components from overheating by automatically shutting down the solar pump. If “SProt Ton” is exceeded for 1 minute at the collector, the pump is switched off and stays off. The pump is activated again when the temperature drops below “SProt TOff”.

*System protection - Setting range: on / off / Default: on*

*SP T on - Setting range: 60 °C ... 150 °C / Default: 120 °C*

*SP T off - Setting range: 50 °C ... T on minus 5 °C / Default: 115 °C*



When system protection is on, the temperature in the idle collector will be very high, thus the pressure in the system will rise and can damage your system. Pay close attention to the system manufacturer’s instructions.

# Special functions

## 7. Special functions



The menu “7. Special functions” is used to set basic items and expand functions.



Other than the time, all settings may only be made by a specialist.

The menu is closed by pressing the “esc” key or selecting “Exit special functions”.

### 7.1. Program selection

The suitable hydraulic variant for the specific application is selected and set here (see “B.6. Hydraulic variants” on page 7). The associated diagram is displayed after pressing “Info”.

*Setting range: 1 ... 3 / Default: 1*



Normally the program selection is made only once during initial commissioning by the specialist. Incorrect program selection can lead to unpredictable errors.

### 7.2. Time and date

This menu is used to set the current time and date.



For analysis of the system data it is essential that the time is set accurately on the controller. Please note that the clock has a 24 hour battery reserve if the mains voltage is interrupted and must therefore be reset afterwards.

### 7.3. Sensor calibration

Deviations in the temperature values displayed, for example due to cables which are too long or sensors which are not positioned optimally, can be compensated for manually here. The settings can be made for each individual sensor in steps of 0.5 °C.

*Offset S1 ... S3 per setting range: -100 ... +100 (translates to -50 °C ... +50 °C)*

*Default: 0 °C*



Settings are only necessary in special cases at the time of initial commissioning by the specialist. Incorrect measurement values can lead to unpredictable errors.

# Special functions

## 7.4. Commissioning

Starting the commissioning help guides you through the basic settings necessary for commissioning in the correct order and provides brief descriptions of each parameter in the display.

Pressing the “esc” key takes you back to the previous value so you can look at the selected setting again or adjust it if desired. Pressing the “esc” key more than once takes you back to the selection mode, thus cancelling the commissioning help. (See also E.2).



May only be started by a specialist during commissioning! Observe the explanations for the individual parameters in these instructions and check whether further settings are necessary for your application.

## 7.5. Factory settings

All of the settings that have been made can be reset, thus returning the controller to its delivery state.



The entire parametrisation, analyses etc. of the controller will be lost irrevocably. The controller must then be commissioned once again.



# Special functions

## 7.6. Heat quantity

A simple heat metering function for basic system control can be activated in this menu. Additional settings regarding the glycol, the percentage of glycol and the flow rate of the system are required.

Additionally Offset  $\Delta T$  can be used to enter a correction value to compensate for the temperature difference between flow and return temperature. Since the collector and the pool temperature are used to calculate the heat quantity, deviations from the displayed temperature can occur.

Example: Displayed collector temp. 40 °C, measured flow temp. 39 °C, displayed storage temp. 30 °C, measured return temp. 31 °C means a setting of -20 % (Displayed  $\Delta T$  10 K, actual  $\Delta T$  8 K => -20 % correction value)

*Heat quantity: on, off / Default: off*

*Flow rate setting: 10 ... 5000 l/h / Default: 500 l/h*

*Offset  $\Delta T$  setting: -50 % ... +50 % / Default: 0 %*



Heat quantity data is only an approximation for function control of the system.



When sensor 3 is connected, the heat quantity is calculated from the temperature data of S1 and S3.

## 7.7. Daylight saving time

When this function is active, the controller's clock changes automatically to and from DST (DST, Daylight Saving Time).

*Default: Yes*

# Menu lock

## 8. Menu lock

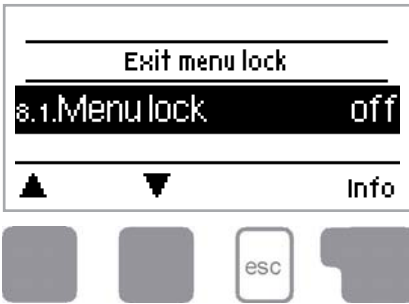

The menu "8. Menu lock" can be used to secure the controller from unintentional changing of the set values.

The menu is closed by pressing the "esc" key or selecting "Exit menu lock".

The menus listed below remain completely accessible despite the menu lock being activated and can be used to make adjustments if necessary:

1. Measurement values
2. Analysis
3. Display mode
- 7.2. Time and date
8. Menu lock
9. Service values

To lock the other menus select "Menu lock on".

To enable the menus again select "Menu lock off".

*Setting range: on, off / Default: off*

# Service values

## 9. Service values

9.3. Tmin S1	20.0°C
9.4. Tmax S2	30.0°C
9.5. Hourly filtering times 10min	
▲ ▼	



The menu “9. Service values” can be used for remote diagnosis by a specialist or the manufacturer in the event of an error etc.



Enter the values at the time when the error occurs e.g. in the table.

The menu can be closed at any time by pressing the “esc” key.

9.1.	
9.2.	
9.3.	
9.4.	
9.5.	
9.6.	
9.7.	
9.8.	
9.9.	
9.10.	
9.11.	
9.12.	
9.13.	
9.14.	
9.15.	
9.16.	
9.17.	
9.18.	
9.19.	
9.20.	
9.21.	
9.22.	
9.23.	
9.24.	
9.25.	
9.26.	
9.27.	
9.28.	
9.29.	
9.30.	

9.31.	
9.32.	
9.33.	
9.34.	
9.35.	
9.36.	
9.37.	
9.38.	
9.39.	
9.40.	
9.41.	
9.42.	
9.43.	
9.44.	
9.45.	
9.46.	
9.47.	
9.48.	
9.49.	
9.50.	
9.51.	
9.52.	
9.53.	
9.54.	
9.55.	
9.56.	
9.57.	
9.58.	
9.59.	
9.60.	

# Language

## 10. Language



The menu “10. Language” can be used to select the language for the menu guidance. This is queried automatically during initial commissioning. The choice of languages may differ, however, depending on the device design.

*Default: Deutsch*



# Malfunctions

## Z.1 Malfunctions with error messages

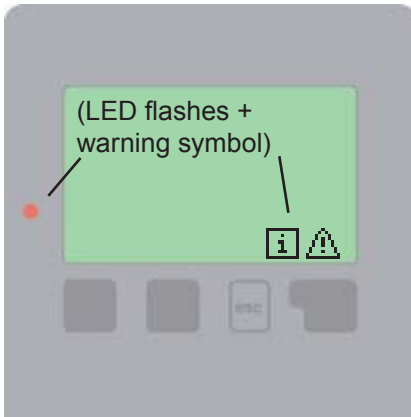

If the controller detects a malfunction, the red light flashes and the warning symbol also appears in the display. If the error is no longer present, the warning symbol changes to an info symbol and the red light no longer flashes.

To obtain more detailed information on the error, press the key under the warning or info symbol.



Do not try to deal with this yourself.  
Consult a specialist in the event of an error!

Possible error messages:

Sensor x faulty ----->

Notes for the specialist:

Means that either the sensor, the sensor input at the controller or the connecting cable is / was faulty.  
(see Resistance table B.1)

Restart ----->

Means that the controller was restarted, for example due to a power failure. Check date and time!

# Malfunctions

## Z.2. Replacing the fuse



Repairs and maintenance may only be performed by a specialist. Before working on the unit, switch off the power supply and secure it from being switched on again! Check for the absence of power!



Only use the spare fuse supplied or a fuse of the same design with the following specifications: T 4 A / 250 V

### Z.2.1

Fuse



If the mains voltage is switched on and the controller still does not function or display anything, the internal device fuse may be faulty. In that case, open the device as described under C, remove the old fuse and check it.

Replace the faulty fuse with a new one, locate the external source of the error (e.g. pump) and repair or replace it.

Then recommission the controller and check the function of the switch outputs in manual mode first as described under 4.2.

## Z.3. Maintenance



In the course of the general annual maintenance of your heating and solar system system you should also have the functions of the controller checked by a specialist and have the settings optimised if necessary.

Performing maintenance:

- Check the time and date (see “7.2. Time and date” on page 23)
- Assess/check plausibility of analyses (see “2. Statistics” on page 16)
- Check the error memory (see “2.5. Message log” on page 16)
- Verify/check plausibility of the current measurement values (see “1. Measurement values” on page 15)
- Check the switch outputs/consumers in manual mode (see “4.2. Manual” on page 18)
- If possible, optimise the parameter settings

# Notes



The service values (see 9.) include not only current measurement values and operating states, but also all of the settings for the controller. Write the service values down once after commissioning has been successfully completed.



In the event of uncertainty as to the control response or malfunctions the service values are a proven and successful method for remote diagnosis. Write the service values down (see 9.) at the time the suspected malfunction occurs. Send the service value table by fax or e-mail with a brief description of the error to the specialist or manufacturer.



To protect against loss of data, record any analyses and data that are particularly important to you (see 2.) at regular intervals.



Filter pump party function: When the “esc” key is pressed for 3 seconds the filter pump switches on for 5 hours.  
This can be canceled by pressing the “esc” key again for 3 seconds.

---

Notes of commissioning:

---

Hydraulic variant set:

Commissioned on:

Commissioned by:

---

---

Final declaration:

Although these instructions have been created with the greatest possible care, the possibility of incorrect or incomplete information cannot be excluded. Subject as a basic principle to errors and technical changes.

---